



## **ETSI M2M solution introduction**

**ETSI Standard  
is enabling global M2M  
communications**



# The M2M connectivity and service models are changing



Connecting Things

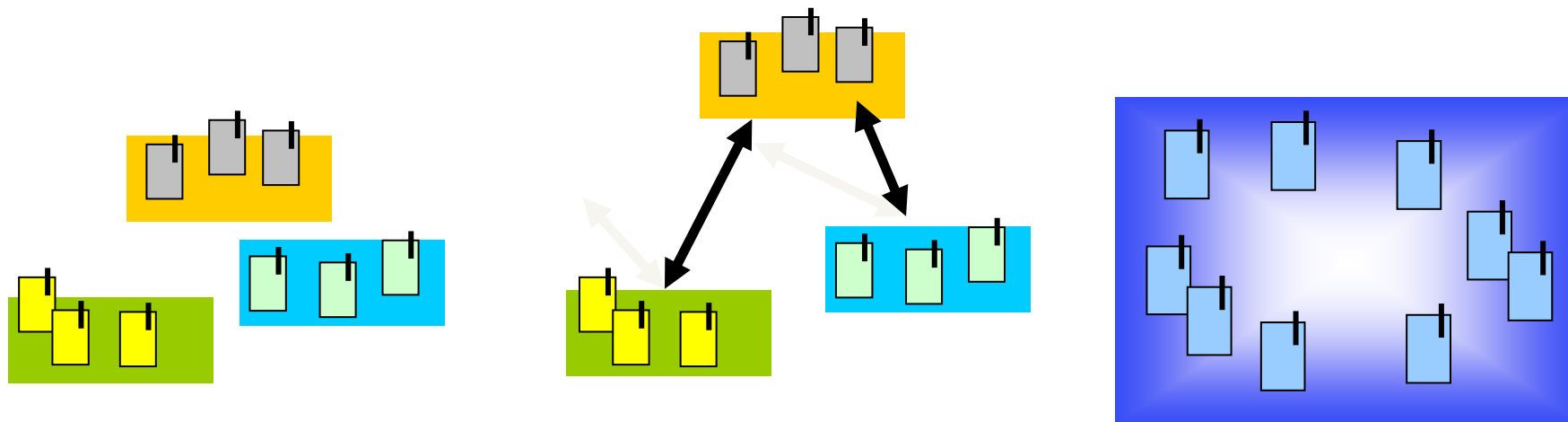

Everyday objects are becoming “things” that can be addressed, recognized, localized and controlled via telecommunication networks

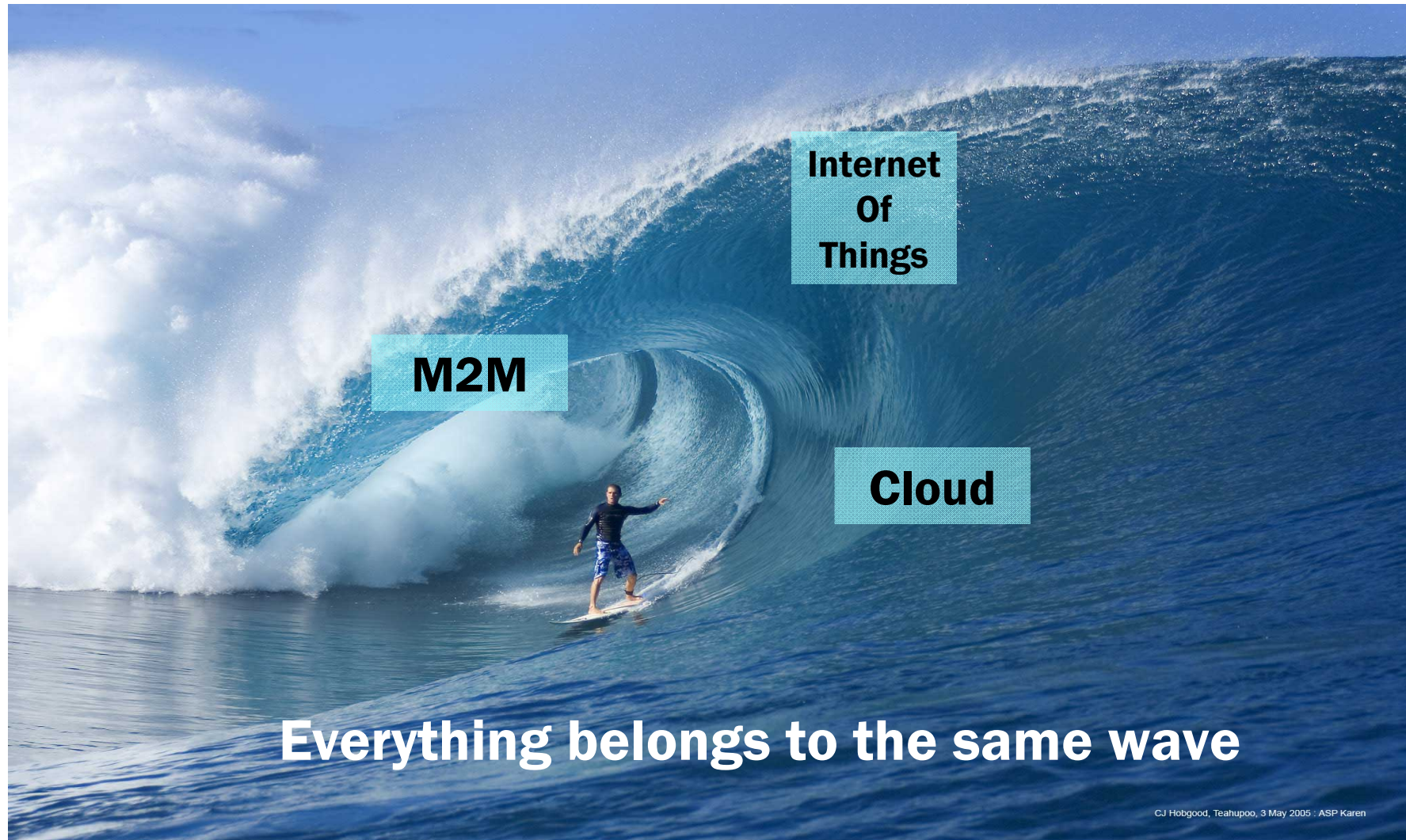

Everything belongs to the same wave

# M2M is multi-Applications



Connecting Things

- Machine-to-Machine (M2M) is about communication among Machines without (or only limited) human intervention

## M2M

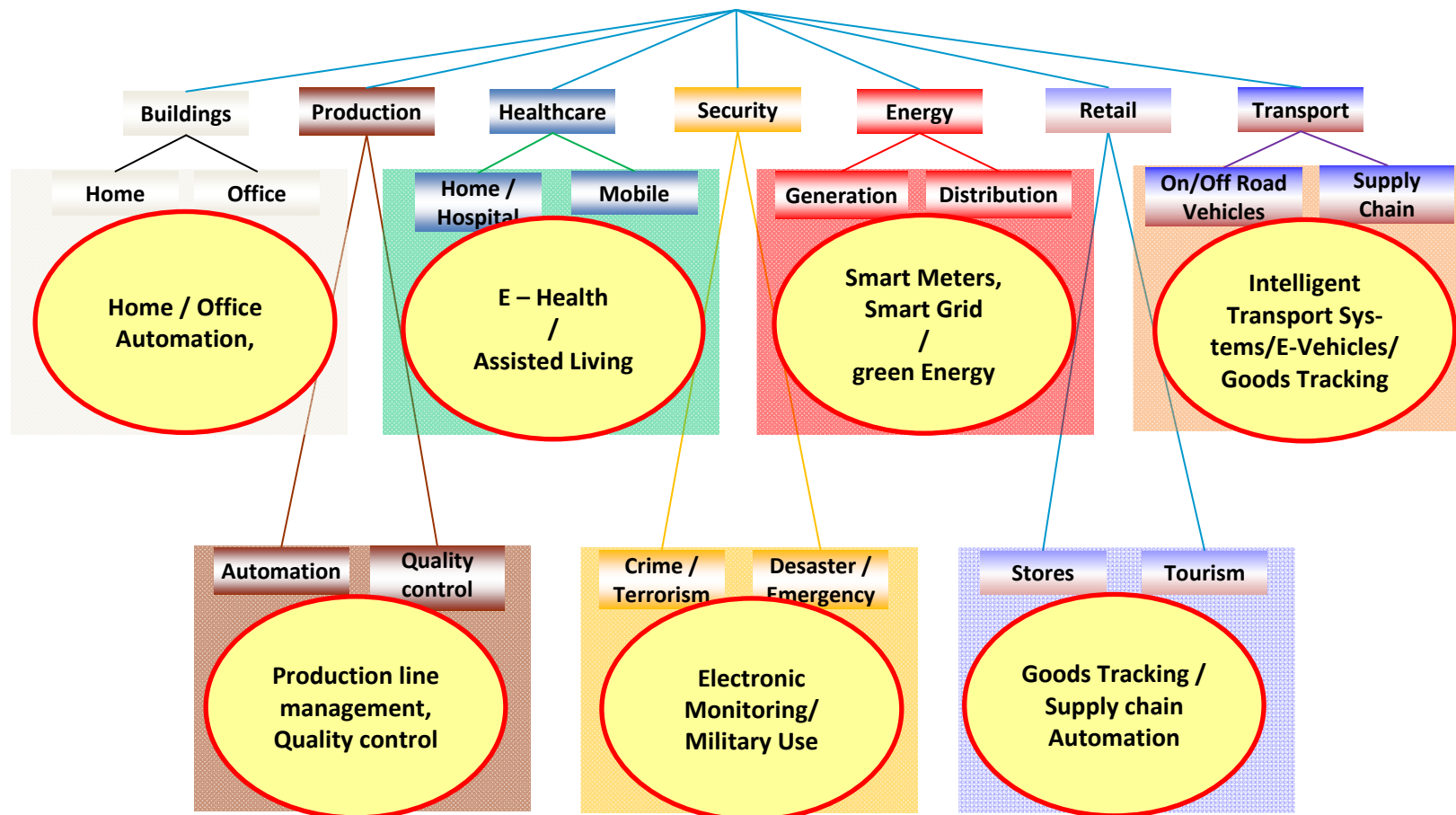

# The ETSI M2M Challenge



Connecting Things

- Existing M2M solutions are highly fragmented and typically dedicated to a single application (e.g. fleet management, meter reading, vending machines).
- Multitude of technical solutions and dispersed standardization activities result in the slow development of the global M2M market.
- Standardization is a key enabler to remove the technical barriers and ensure interoperable M2M services and networks

# M2M stovepipes to integrated offerings



Connecting Things

**Pipe#1**  
1 Application,  
1 Network  
1 (or few) types of Device

**Pipe#2**  
1 Application,  
1 Network  
1 (or few) types of Device

**Pipe#N**  
1 Application,  
1 Network  
1 (or few) types of Device

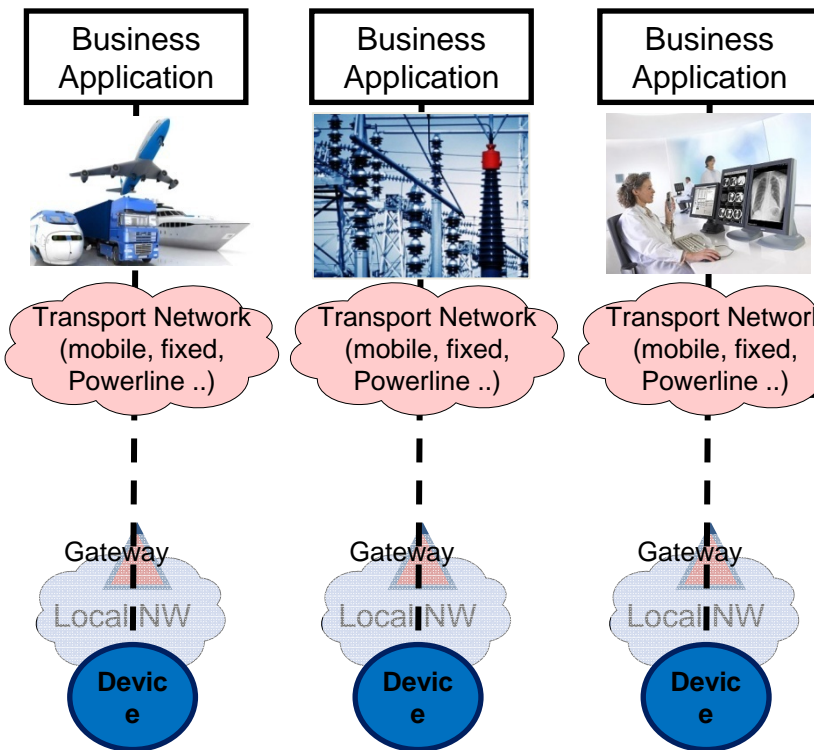

## Horizontal (based on common Layer)

Applications share common infrastructure, environments and network elements

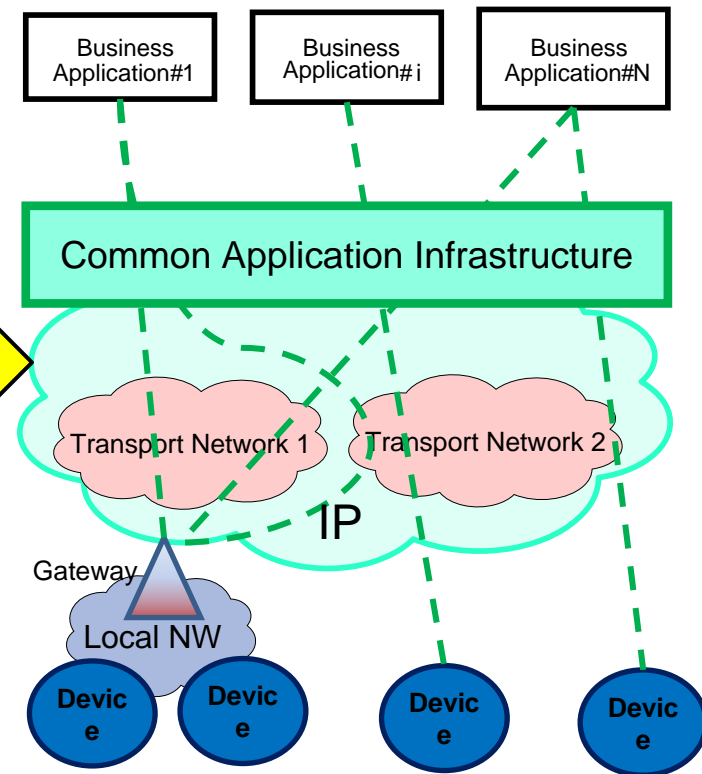

# Enabling information sharing



Connecting Things

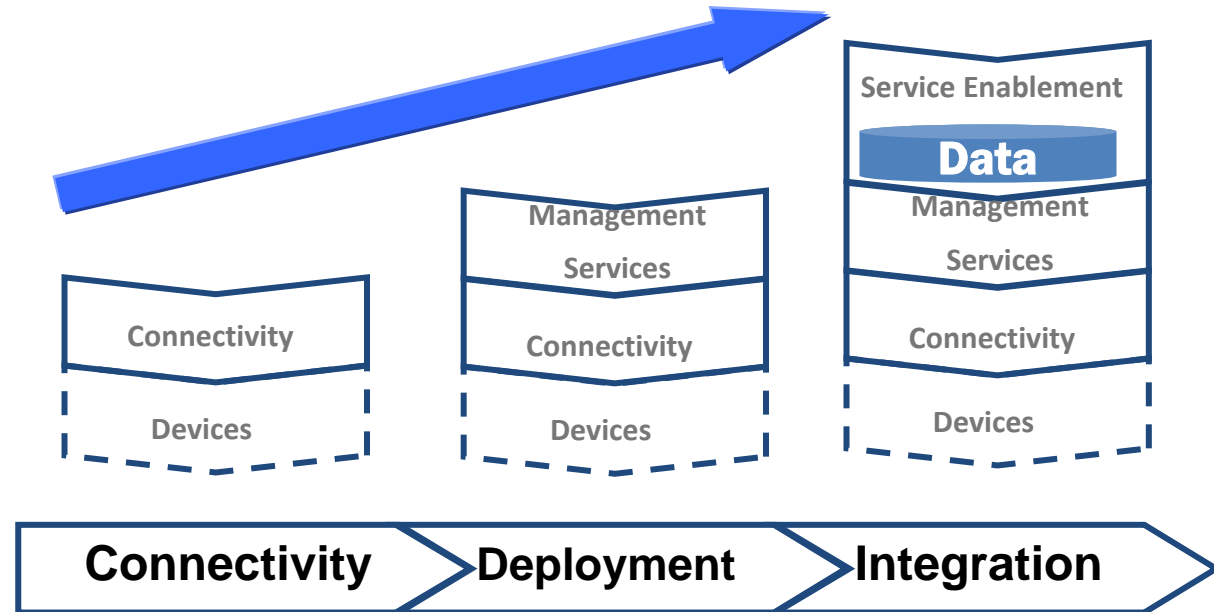

- ETSI M2M is based on a “Store and Share” paradigm
- The data may be made available in the platform to the other applications, interested application are notified by means of subscription
- Privacy is ensured by a strict Access Rights Management



# The ETSI M2M Vision



Connecting Things

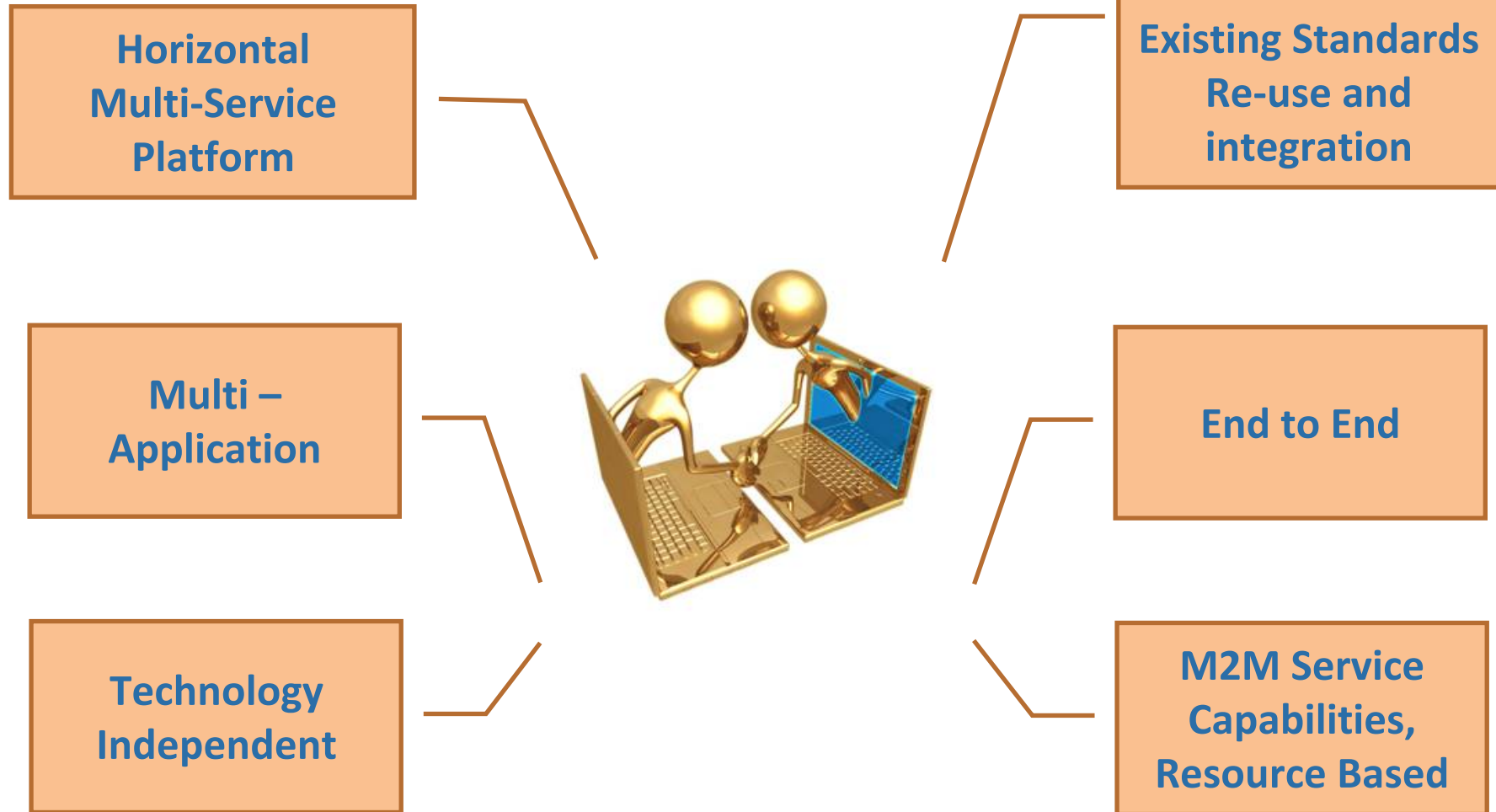

# Value of a standardized horizontal M2M service layer



Connecting Things

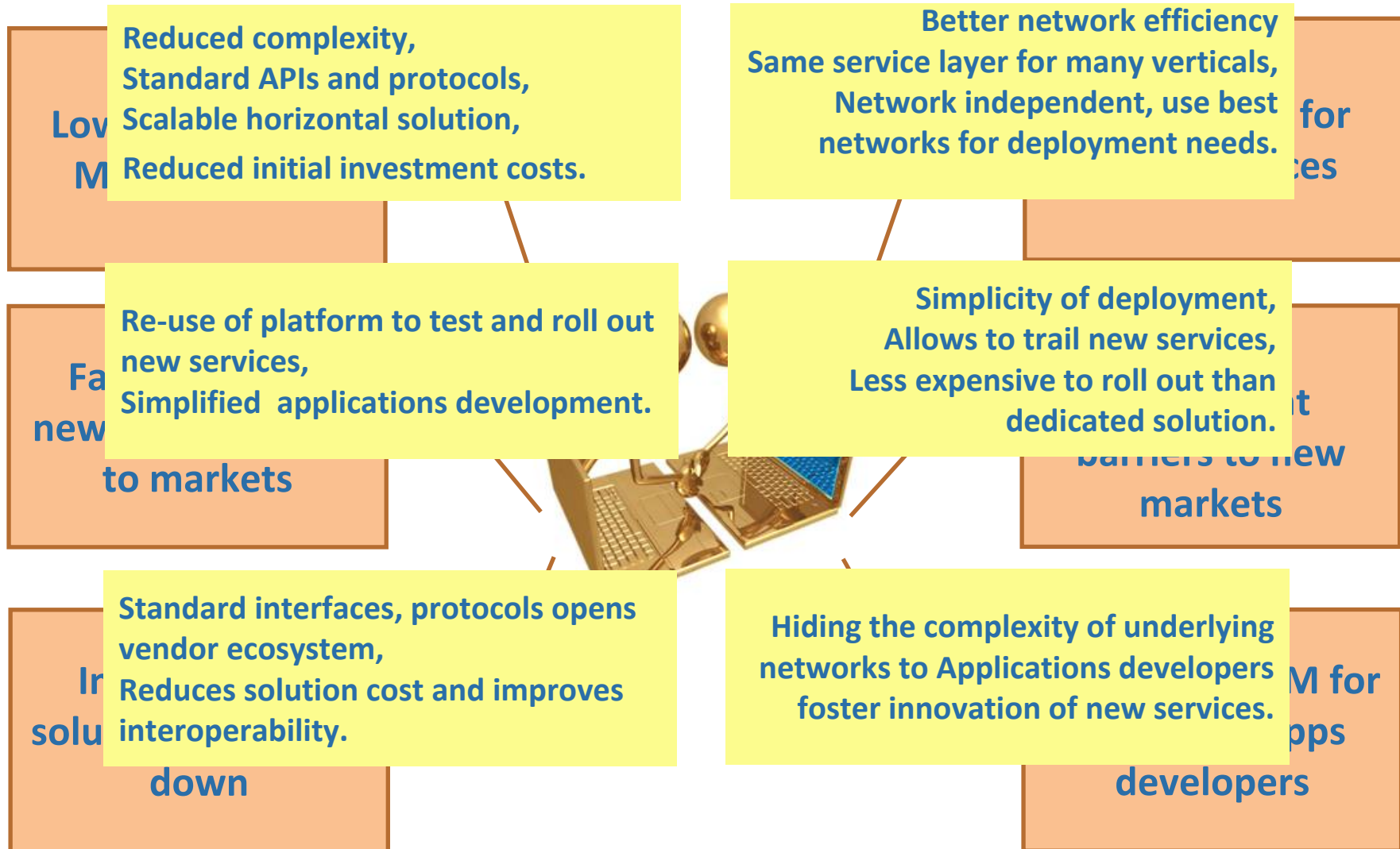

# Example: EU driven mandates

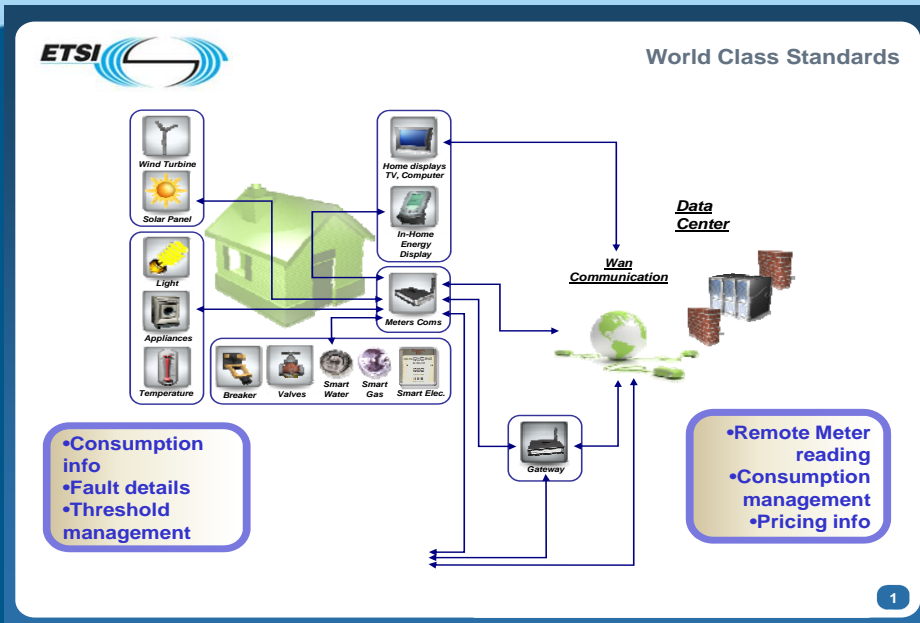

## EC's M/411 Smart Metering Mandate:

- EC Mandate issued in March 2009 by DG TREN and sent to the 3 ESO's : CEN, CENELEC and ETSI
- Objective: to build standards for European smart meters, allowing interoperability and Consumer actual consumption awareness

## EC's M/490 Smart Grid Mandate:

- EC Mandate issued in March 2011 by DG TREN and sent to the 3 ESO's : CEN, CENELEC and ETSI
- Objective: to build standards for European Smart Grids.

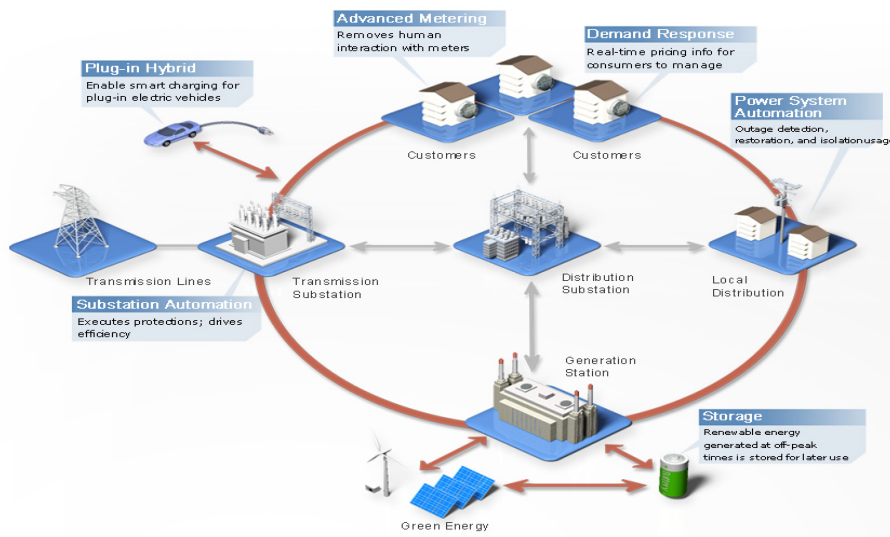

# ETSI M2M use cases



Connecting Things

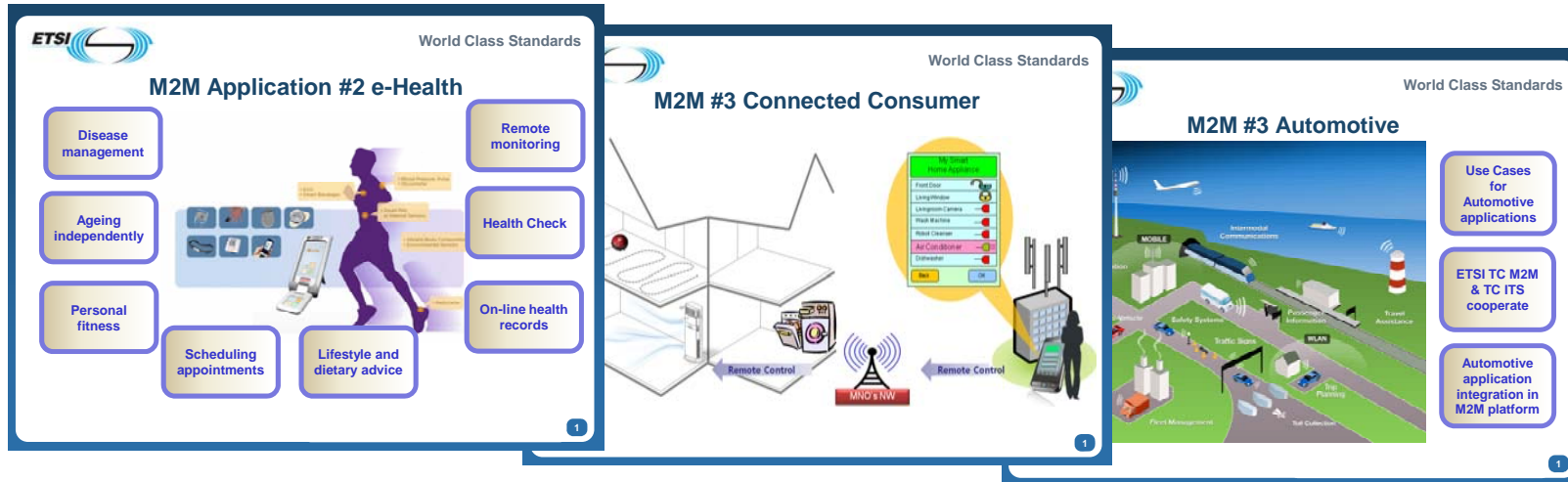

DTR/M2M-00003	102 691	Smart Metering Use Cases
DTR/M2M-00005	102 732	Use cases of eHealth
DTR/M2M-00006	102 857	Use cases of connected consumer
DTR/M2M-00007	102 897	City Automation Use Cases
DTR/M2M-00008	102 898	Automotive Use Cases
DTR/M2M-00011	102 935	Smart Grids

# Simplified M2M Architecture



Connecting Things

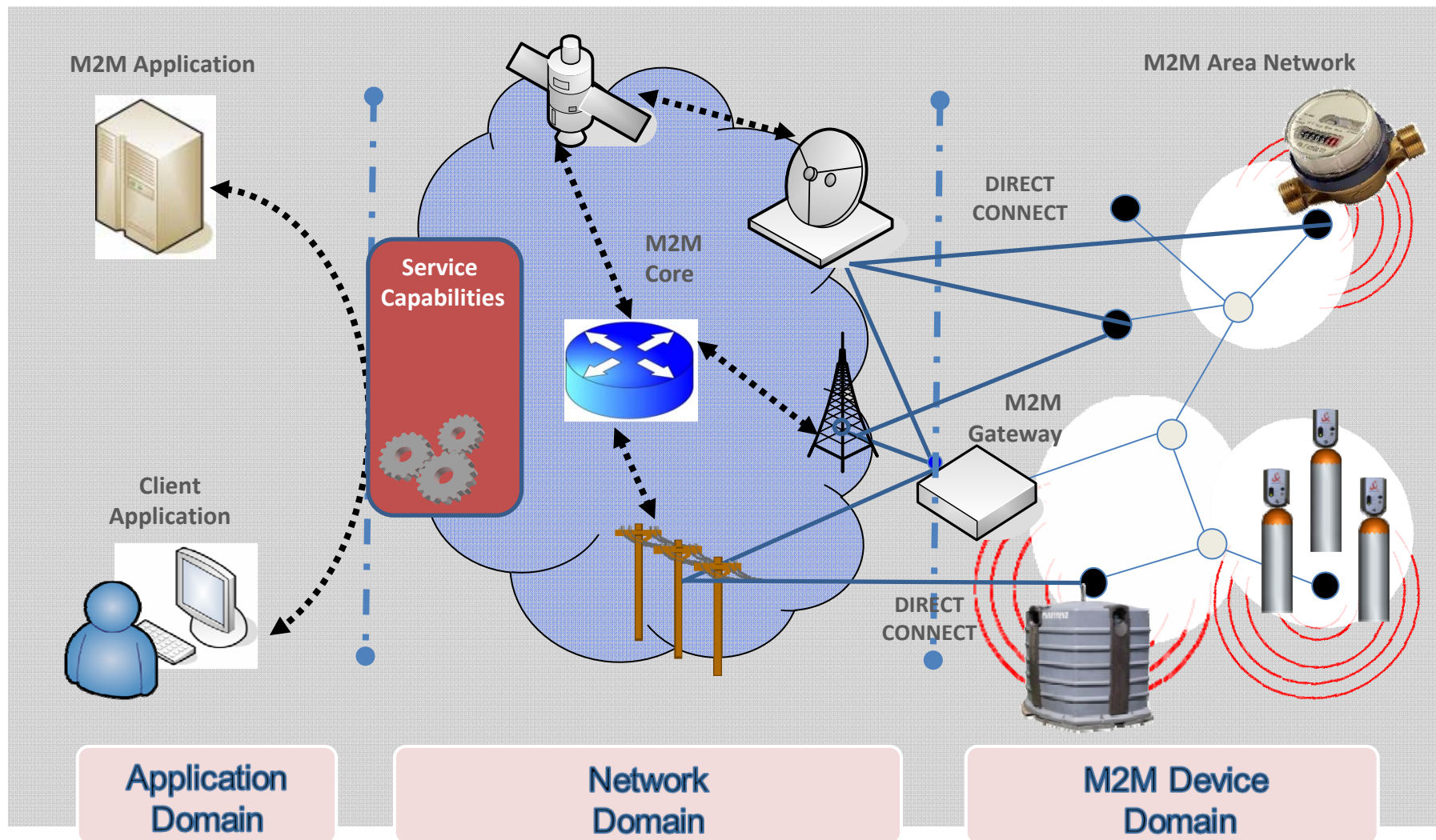

# ... based on existing Technologies



## Connecting Things

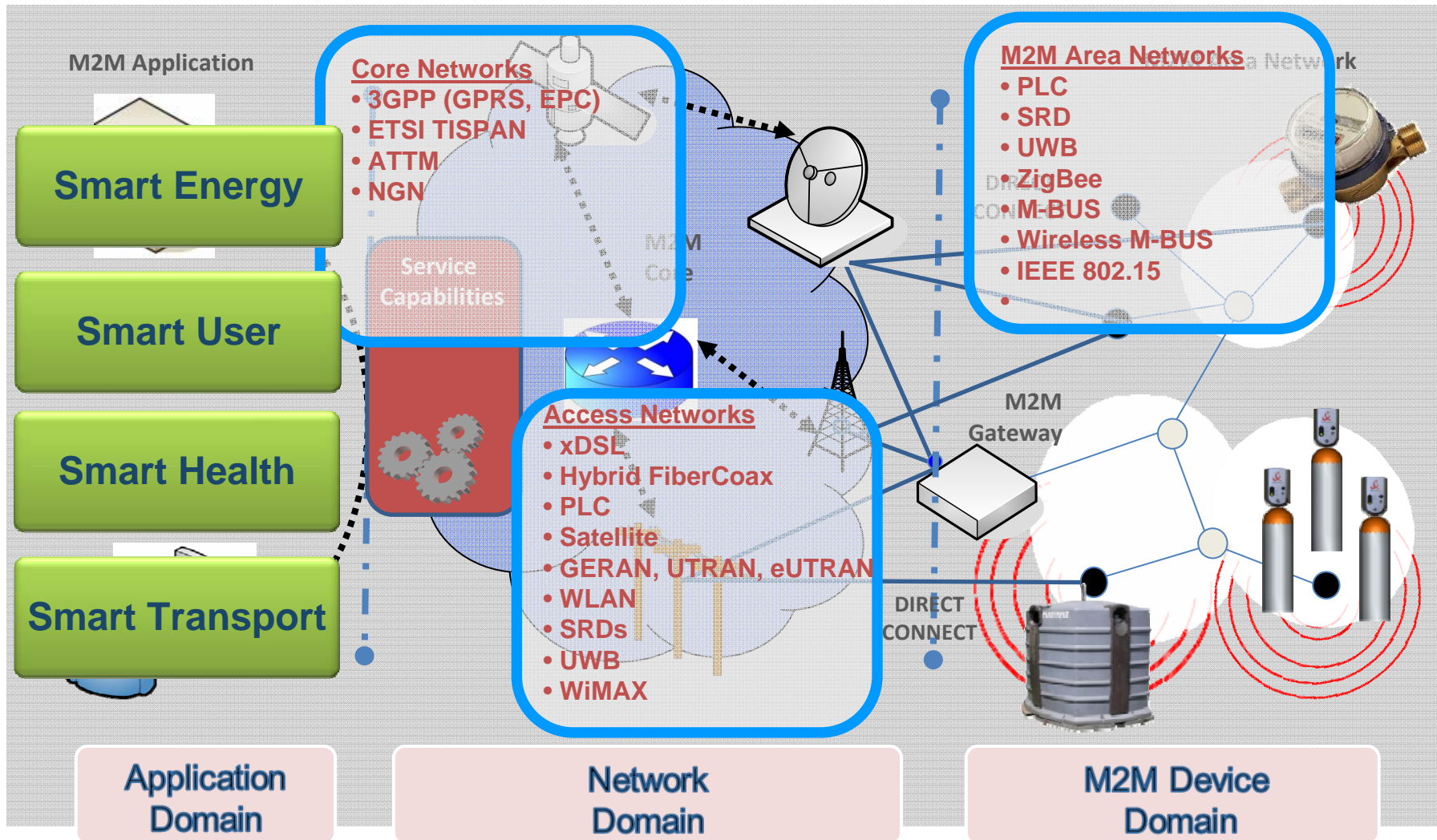



# M2M high level system overview



## Connecting Things

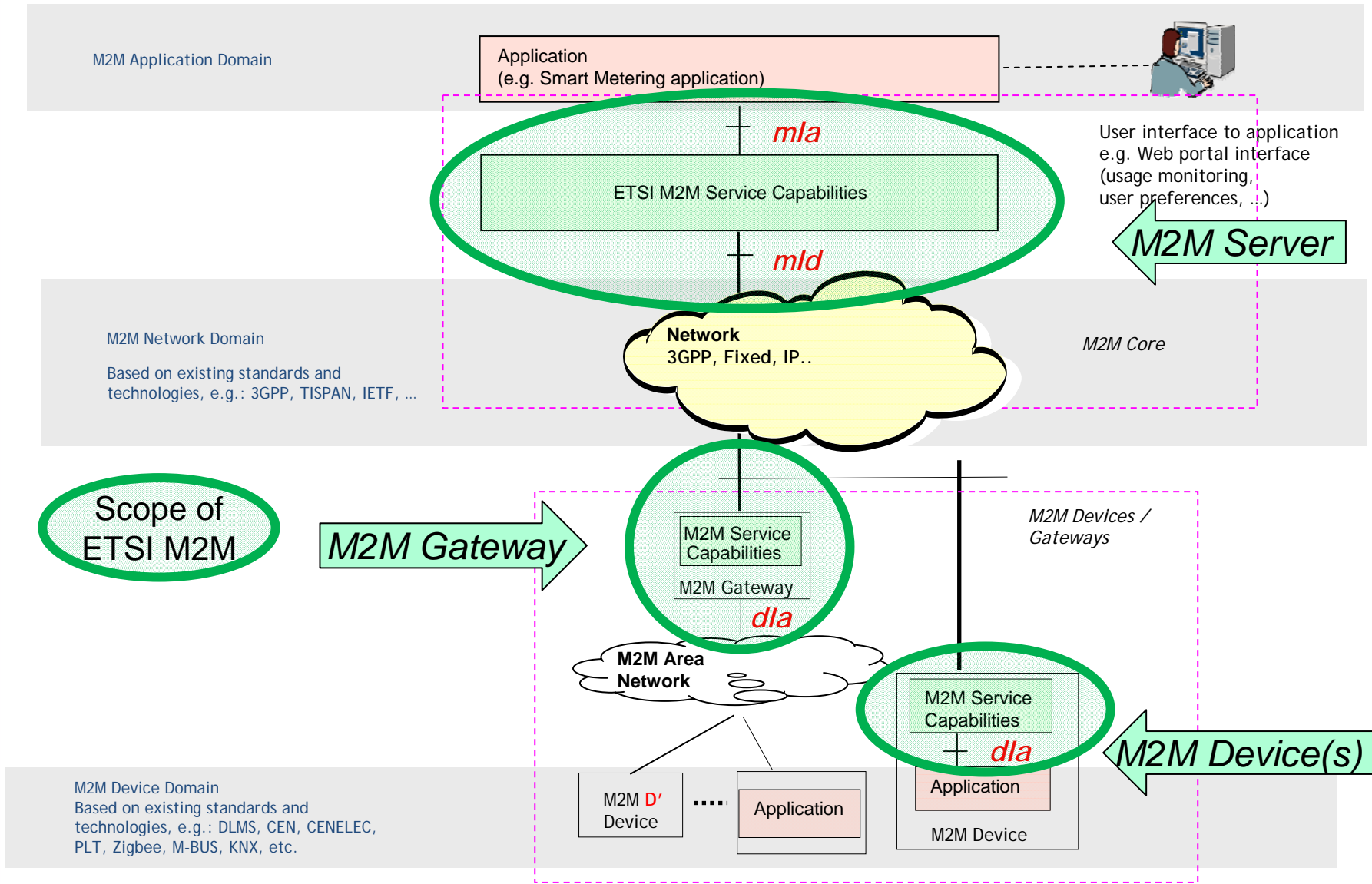



# Key M2M Elements



## Connecting Things

### **M2M Device**

- Device capable of replying to request for data contained within those devices or capable of transmitting data autonomously.

### **M2M Area Network (Device Domain)**

- Provide connectivity between M2M Devices and M2M Gateways, e.g. personal area network.

### **M2M Gateway**

- Uses M2M capabilities to ensure M2M Devices inter-working and interconnection to the communication network.

### **M2M Communication Networks (Network Domain)**

- Communications between the M2M Gateway(s) and M2M application(s), e.g. xDSL, LTE, WiMAX, and WLAN.

### **M2M Applications**

- Contains the middleware layer where data goes through various application services and is used by the specific business-processing engines.

# M2M architecture principles



Connecting Things

- ETSI M2M has adopted a RESTful architecture style
  - Information is represented by resources which are structured as a tree
- ETSI M2M standardizes the resource structure that resides on an M2M Service Capability Layer (SCL)
  - Each SCL contains a resource structure where the information is kept
- M2M Application and/or M2M Service Capability Layer exchange information by means of these resources over the defined reference points
- ETSI M2M standardizes the procedure for handling the resources

# Features offered by ETSI M2M



## Connecting Things

- Identification of the M2M Application and the M2M Devices
- Asynchronous and synchronous communication
- Store and forward mechanism based on policies for optimizing the communication
- Location information
- Device management based both on OMA DM (wireless) and BBF TR-69 (wireline)
- Mutual authentication between Network Service Capability Layer and Device/Gateway Service Capability Layer that are connected
- Secure channel for transporting data over m1d reference point
- And much more ....

- R1 provides standardized security mechanism for the reference point *mld*
- The device/gateway needs to have keys for securing the connection.
- The device/gateway is provisioned with the key M2M Root Key.
- The high level procedure are to
  - Perform mutual *mld* end point authentication
  - Perform M2M Connection Key agreement
  - Optionally establish a secure session over *mld*.
  - Perform RESTful procedures over the *mld*

# M2M standards landscape



Connecting Things

M2M Applications



API

M2M Platform



SP networks  
(access, core)



Gateway Layer



M2M area Network



M2M Device



Example for metering applications

# ETSI M2M full Release 2 Architecture

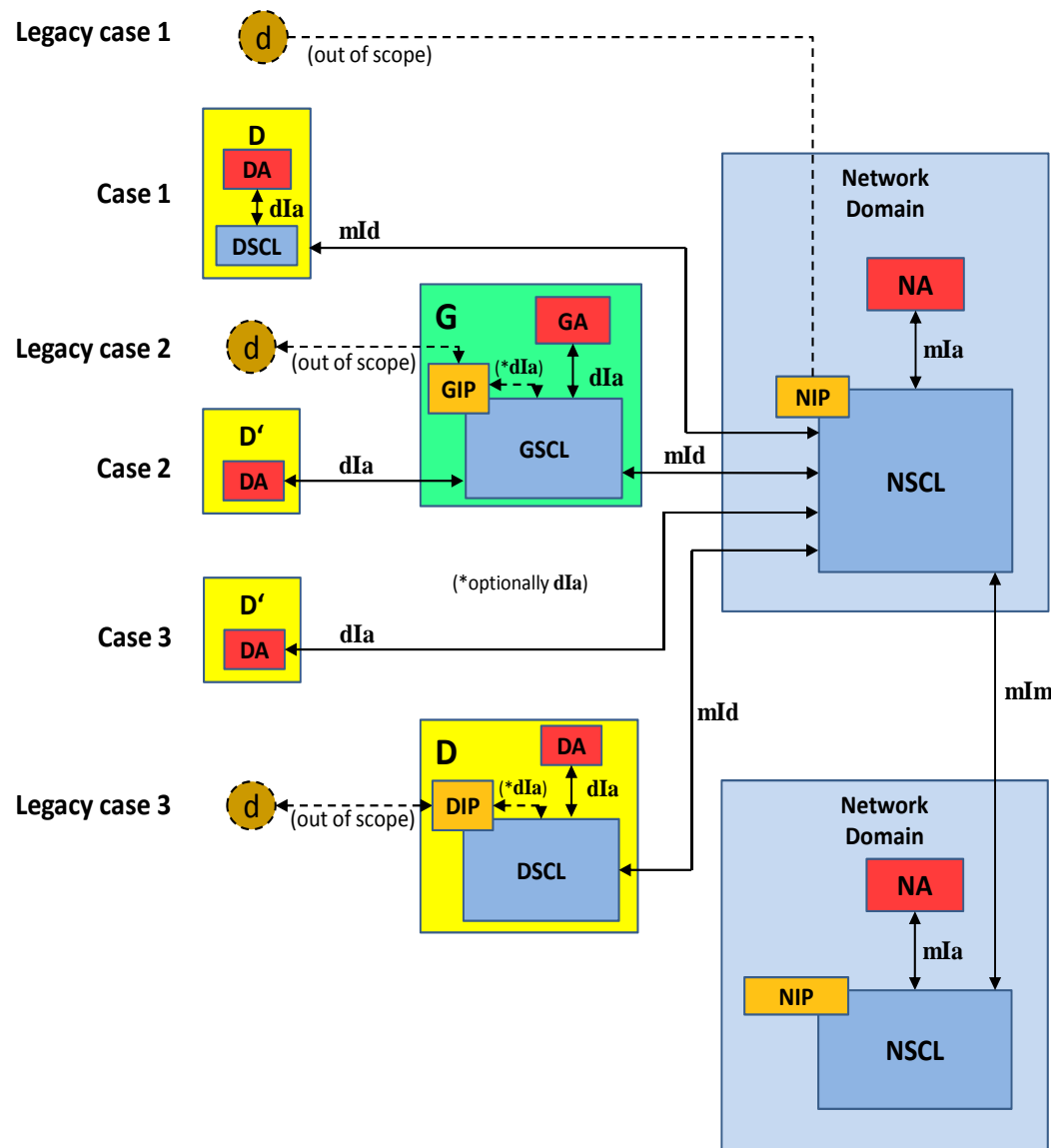

- ▶ **Gateway (G):** provides M2M Service Capabilities (GSCL) that communicates to the NSCL using the mId reference point and to DA or GA using the dIa reference point.
- ▶ **Device (D):** provides M2M Service Capability (DSCL) that communicates to an NSCL using the mId reference point and to DA using the dIa reference point.
- ▶ **Device' (D'):** hosts DA that communicates to a GSCL or to NSCL using the dIa reference point. D' does not implement ETSI M2M Service Capabilities.
- ▶ Additionally there is a non-ETSI M2M compliant device ('d') that connects to SCL using the xIP Capability (NIP, GIP, DIP). d devices do not use ETSI M2M defined reference protocols/API

# TC M2M Release 2 major additions



Connecting Things

- **Charging**: definition of the architectural framework for recording, tracking and exchange of events relevant for the collection of statistical information and for the exchange of charging information, including correlation with charging information from the underlying network
- **Inter-domain** communications between service platforms, i.e. inter-NSCL communication, on mlm reference point (a variant of mld). This allow application in a domain to exchange information with application in a different domain, in a transparent way respect to the domain they belong to.
- **M2M Light**: ETSI M2M Release1 was already supporting very constrained devices via gateways, in Release 2 very constrained device can connect directly to the network platform. Implementation has been made on made on USB dongles.
- **Semantic interworking** guidelines common semantic rules has been defined for applications belonging to different industrial segment, to assure the understanding of the shared data, for a very wide set of commonly used technologies

## Release 1

- Core Release1 Finalized in November 2011 to support urgent market needs and provides an end-to-end architecture to support multiple M2M-type applications.

[http://www.etsi.org/WebSite/NewsandEvents/2012\\_02\\_M2M\\_standards\\_release.aspx](http://www.etsi.org/WebSite/NewsandEvents/2012_02_M2M_standards_release.aspx)

- Extended Release2 Finalized in December 2013 to complement and extend release 1, enabling very constrained devices and facilitating inter-service provider communication .

- Etsi M2M Standard specifications are freely accessible

<http://docbox.etsi.org/smartM2M/Open> and [www.etsi.org](http://www.etsi.org)



# ETSI M2M/SmartM2M available Specifications Work



Connecting Things

## Use Cases [Stage 0]

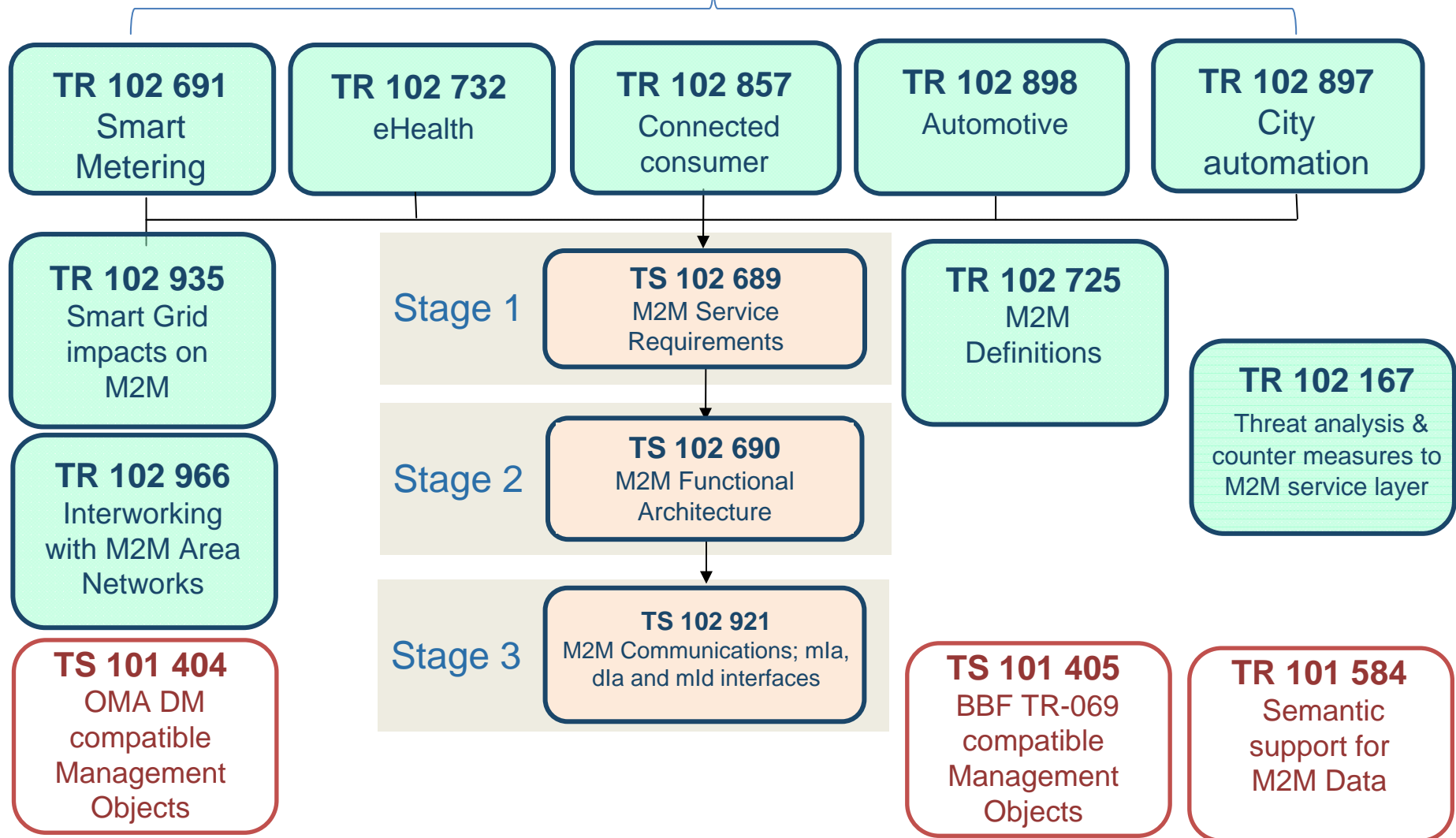

# Major ETSI M2M/SmartM2M specifications



Connecting Things

<b>TS 102 689</b> M2M Service Requirements	<a href="http://www.etsi.org/deliver/etsi_ts/102600_102699/102689/02.01.01_60/ts_102689v020101p.pdf">http://www.etsi.org/deliver/etsi_ts/102600_102699/102689/02.01.01_60/ts_102689v020101p.pdf</a>
<b>TS 102 690</b> M2M Functional Architecture	<a href="http://www.etsi.org/deliver/etsi_ts/102600_102699/102690/02.01.01_60/ts_102690v020101p.pdf">http://www.etsi.org/deliver/etsi_ts/102600_102699/102690/02.01.01_60/ts_102690v020101p.pdf</a>
<b>TS 102 921</b> M2M Communications; mla, dla and mld interfaces	<a href="http://www.etsi.org/deliver/etsi_ts/102900_102999/102921/02.01.01_60/ts_102921v020101p0.zip">http://www.etsi.org/deliver/etsi_ts/102900_102999/102921/02.01.01_60/ts_102921v020101p0.zip</a>
<b>TR 102 725</b> M2M Definitions	<a href="http://www.etsi.org/deliver/etsi_tr/102700_102799/102725/01.01.01_60/tr_102725v010101p.pdf">http://www.etsi.org/deliver/etsi_tr/102700_102799/102725/01.01.01_60/tr_102725v010101p.pdf</a>
<b>TS 103 092</b> OMA DM compatible Management Objects	<a href="http://www.etsi.org/deliver/etsi_ts/103000_103099/103092/02.01.01_60/ts_103092v020101p.pdf">http://www.etsi.org/deliver/etsi_ts/103000_103099/103092/02.01.01_60/ts_103092v020101p.pdf</a>
<b>TS 103 093</b> BBF TR-069 compatible Management Objects	<a href="http://www.etsi.org/deliver/etsi_ts/103000_103099/103093/01.01.01_60/ts_103093v010101p.pdf">http://www.etsi.org/deliver/etsi_ts/103000_103099/103093/01.01.01_60/ts_103093v010101p.pdf</a>
<b>TR 102 966</b> Interworking with M2M Area Networks	<a href="http://www.etsi.org/deliver/etsi_tr/102900_102999/102966/01.01.01_60/tr_102966v010101p.pdf">http://www.etsi.org/deliver/etsi_tr/102900_102999/102966/01.01.01_60/tr_102966v010101p.pdf</a>
<b>TR 101 584</b> Semantic support for M2M Data	<a href="http://www.etsi.org/deliver/etsi_tr/101500_101599/101584/02.01.01_60/tr_101584v020101p.pdf">http://www.etsi.org/deliver/etsi_tr/101500_101599/101584/02.01.01_60/tr_101584v020101p.pdf</a>

# M2M– Workshops



Connecting Things

- ETSI M2M had also created a series of highly popular technical workshops. With more than 240 participants and live demonstrations of real life implementations of ETSI M2M specifications .

Here follows some links where useful documentation is also available

Videos <http://cftvideo.com/etsi/m2mdemos/>

2011- <http://www.etsi.org/index.php/news-events/events/542-2nd-etsi-tc-m2m-workshop-from-standards-to-implementation>

2012- <http://www.etsi.org/news-events/news/609-2012-m2mworkshop>

2013- <http://www.etsi.org/news-events/past-events/666-2013-m2mworkshop>

**2014 - 10-11 December 2014**

# ETSI M2M/smartM2M mandates



Connecting Things

- Support the European Commission Mandates in M2M and IoT areas; leading and coordinating the ETSI answer to:
  - Smart Metering (M/441) in collaboration with CEN/CENELEC
  - Smart Grid (M/490) in collaboration with CEN/CENELEC
  - Charging of Electrical Vehicles (M/468)
- Addressing the Smart Cities and other application specific M2M needs

**ETSI SmartM2M is supporting Smart Appliances communication standardization and opened a set of work items:**

- To accommodate the result of the Study group,
- To complement it with proper communication framework
- To provide testing support

# Principles and approach in SmartM2M



## Connecting Things

- **Openness: The specification will be developed according to ETSI procedures, nevertheless it is of interest of all the parties to have the wider participation possible, so the ETSI TB will invite the directly participation of all the interested stakeholders to the ETSI SmartM2M SAP discussions, as well via LS or via the ETSI Members.**
- **The main technical contribution for the semantic/ontology part will be the reports from the Study Group. Study group and expert group need to be invited to the Smart M2M Sap discussions. It is expected that such common ontology will take into account all the interest of the relevant stakeholders, so it can go smoothly into standardization**
- **The communication framework will be based on the reuse of ETSI/oneM2M, with the understanding that such communication framework is designed to support M2M/IoT communication with a specific attention to the interworking among different semantics/ontologies.**

# Draft TS 103.265 on SAP Common ontology



## Connecting Things

- Scope
  - To specify the common semantic/ontology, and to specify the mapping on the SmartM2M/oneM2M communication data model
- Content
  - Derived from the SG and standardized by SmartM2M
    - SAP Common Data model
    - SAP Common Ontology
  - Developed in Smart M2M and standardized by SmartM2M
    - Mapping of SAP data model on the elementary ETSI M2M/oneM2M resources and services
- Schedule
  - WI approval and draft ToC May 2014
  - Target date for ETSI approval May 2015
  - Target date for Publication July 2015
  - Current work item status  
[http://webapp.etsi.org/WorkProgram/Report\\_WorkItem.asp?WKI\\_ID=44091](http://webapp.etsi.org/WorkProgram/Report_WorkItem.asp?WKI_ID=44091)
  - Latest draft: [http://docbox.etsi.org/SmartM2M/Open/Latest\\_Drafts/](http://docbox.etsi.org/SmartM2M/Open/Latest_Drafts/)

# TS 103.267 on SAP

## communication solution and Interworking



### Connecting Things



#### Scope

- To specify the SAP communication framework based on ETSI SmartM2M/oneM2M specifications
- To complement the specification with any adaptation needed to assure the interworking for SAP



#### Content

- General informative description of the ETSI M2M/oneM2M framework in the SAP context.
- Normative description of the SAP interworking framework with normative reference to ETSI M2M/oneM2M specification
- Specification of all the required common initial configuration and setting to assure a full interworking with plug and play support for Smart Appliances



#### Schedule

- WI approval and draft ToC May 2014
- Target date for ETSI approval May 2015
- Target date for Publication July 2015
- Current work item status  
[http://webapp.etsi.org/WorkProgram/Report\\_WorkItem.asp?WKI\\_ID=440912](http://webapp.etsi.org/WorkProgram/Report_WorkItem.asp?WKI_ID=440912)
- Initial skeleton: [http://docbox.etsi.org/SmartM2M/Open/Latest\\_Drafts/](http://docbox.etsi.org/SmartM2M/Open/Latest_Drafts/)



# TS 103.268 on SAP communication and ontology testing



Connecting Things

## Scope

- Provide interoperability advise
- To identify the test priorities
- To specify the test suites

## Content

- tbd

## Schedule

- WI approval and draft ToC September 2014
- Target date for ETSI approval 4Q 2015
- Target date for Publication 1Q 2016
- Crrrent work item status

[http://webapp.etsi.org/WorkProgram/Report\\_WorkItem.asp?WKI\\_ID=44099](http://webapp.etsi.org/WorkProgram/Report_WorkItem.asp?WKI_ID=44099)

- Initial skeleton: Not yet available